

RoHS
COMPLIANT

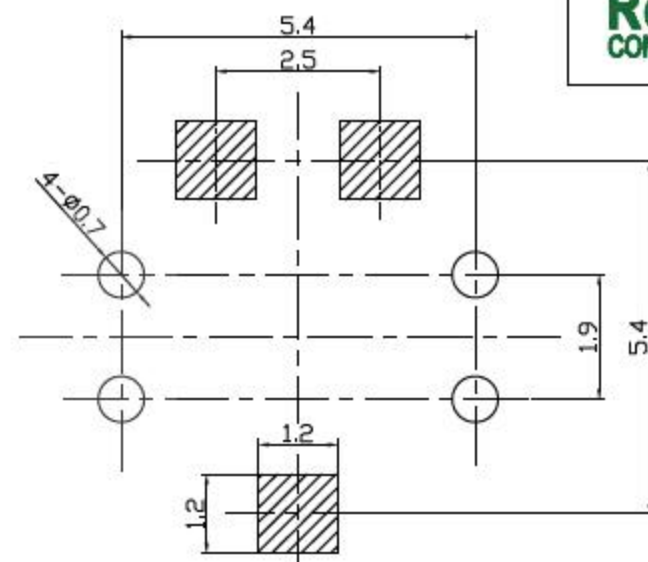

安装尺寸图

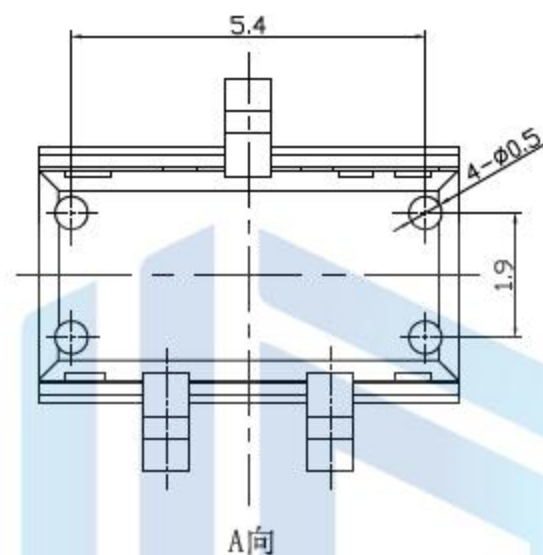
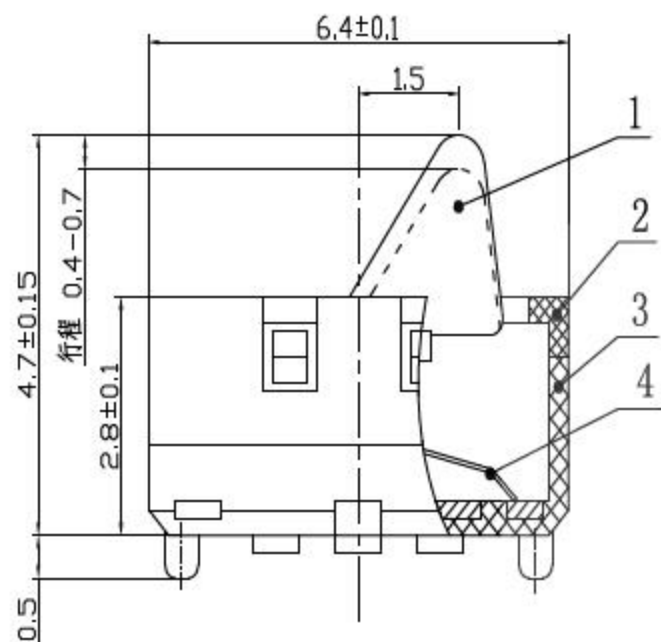
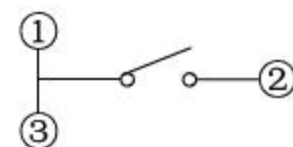
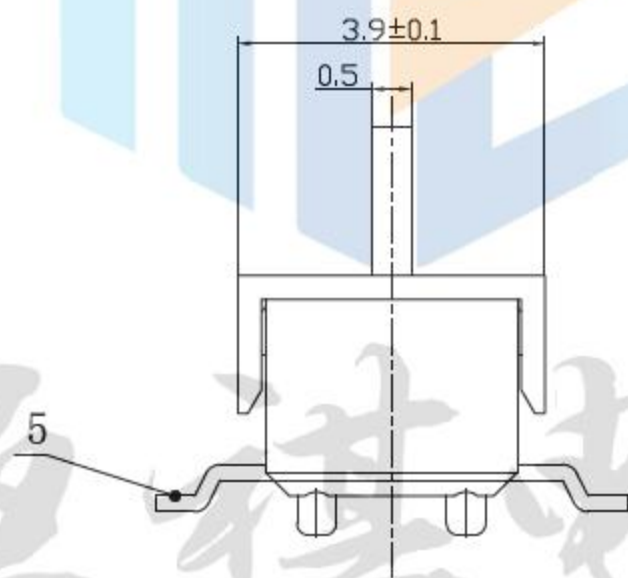
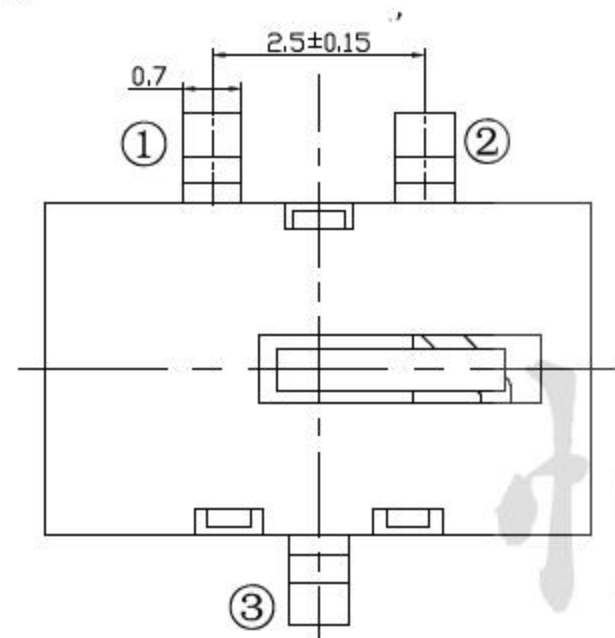

电路原理图

额定范围: 50mA DC12V
 绝缘电阻: $\geq 100M\Omega$ min(DC100V)
 接触电阻: $\leq 300m\Omega$
 耐压强度: AC100V (50/60Hz foy 1minute)
 机械寿命: 50,000 cycles
 操作温度: $-10^{\circ}C \sim +60^{\circ}C$
 操作力度: $50 \pm 30gf$

设计:	Arvin: 2016.03.08	范围 Range	公差 Tolerance
审核:	Arvin:	X.X ±	X.X ±0.30
校对:	Ru yi:	X.XX ±	X.XX ±0.20
比例:	视角关系: $\oplus \triangleleft$	X.XXX ±	X.XXX ±0.10
版次:	图框大小: A4	Angle ±	Angle ±5°

东莞市恒祺电子科技有限公司

名称: 检测开关 料号:

型号: KFC-VT-07

共 张 , 第 张

备注: